

CHAPITRE IV

REFROIDISSEMENT POMPES A EAU DE MER TURBINES ET KITS REPARATION

Pages 55 à 70

POMPES EAU DE MER TOUTES MARQUES

Toute la pièce au détail
Pompes eau de mer neuves / rénovées / échange standard
Turbine + joint de plaque

KIT ETANCHEITE

- Turbine
- Joint
- Garniture
- Tous les joints de plaque intérieure

KIT REPARATION

- Kit étanchéité
- Roulement
- Plaque usure
- Came et vis
- Couvercle et vis





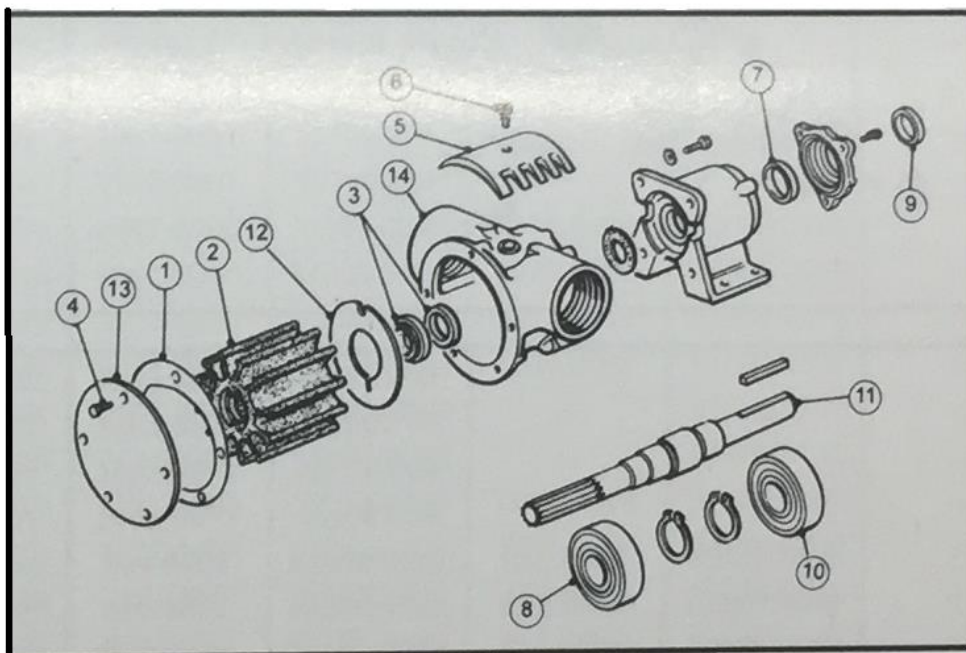

Sont vendus au détail les arbres et certains corps

Atelier de réparation de pompe à eau sur place



POMPES DE BRASSAGE

POMPES CIRCULATION GM / FORD ESSENCE

<p>SDM15100 POMPE BASE GM 4 & 6 Cyl</p> 	<p>SDM15201 POMPE BASE GM V6 & V8</p> 	<p>SDM15301 POMPE BASE GM V8 7.4L</p> 
<p>SDM15400 POMPE BASE FORD V8 302 / 351</p> 	<p>SDM15202 POMPE EAU 2.3L FORD New</p> 	<p>SDM15800 POMPE EAU 7.5L FORD</p> 
Référence		Désignation
SDM15100	Brasseur 4 cyl /6 cyl GM	
SDM15201	Brasseur GM V6 V8	
SDM15202	Pompe brassage V6 V8 new	
SDM15301	Brasseur GM 7.4L	
SDM15556	Brasseur GM 8.1l	
SDM15700	Brasseur FORD 2.3L 4 cyl essence	
SDM15400	Brasseur FORD 5L 5.8 L	
SDM15800	Brasseur 7.5L FORD	

POMPES EAU DE MER

MARQUE	TYPE MOTEUR	POMPE COMPLETE	TURBINE	KIT ETANCHEITE	KIT REPARATION
BETA MARINE	D772/D1005	PM.N375	T.101	PM.K	PM.K1495
	1205/1305/1505 V1903/V2203/V2803	PM.BE1928	T.107	PM.K	PM.K1384
BMW	D7 / D12	PM.BM712	T.121	PM.K	PM.K1492
	D35 / D50	PM.BM3550	T.101	PM.K	PM.K1495
	B130 / B190 / B220	PM.N4	T.107	PM.K	PM.K1503
	D150 / D190 / D636 530	PM.VM36	T.106	PM.K	PM.K1499
BUCK	DV10 / DV20	PM.BU10	T.101	PM.K	PM.K1495
	DV10M / DV20M	PM.BU20	T.121	PM.K	PM.K1496
	DV24 / DV36 / 48	PM.BU3648	T.121	PM.K	PM.K1496
CATERPILLAR	3208 JOHNSON/JABSCO	PM.CA3208J	T.135	PM.K	PM.K1506
	SHERWOOD	VOIR TABLEAU SHERWOOD			
CHRYSLER	F181	PM.CH6740	T.107	PM.K	S.D
COUACH	VOIR TABLEAU COUACH				
CUMMINS	V504 JOHNSON	PM.CU504	T.107	PM.K	PM.K1299
	V555 JOHNSON	PM.CU555	T.107	PM.K	PM.K1299
	V903 JOHNSON	PM.CU903	T.135	PM.K	PM.K5222
	SHERWOOD	VOIR TABLEAU SHERWOOD			
DAF	475 / 575	PM.DA475	T.114	PM.K	PM.K1179
	1160	PM.DA1160	T.105	PM.K	PM.K1579
DETROIT DIESEL	6V53 / 8V53 / 6V71	PM.DD6V71	T.135	PM.K	PM.K1190
	8V71	PM.DD8V71	T.135	PM.K	PM.K1065
	8V92	PM.DD8V92	T.152	PM.K	PM.K1190
	12V71TI 12V92TA	PM.DD12V92	T.135	PM.K	PM.K1190
FARYMAN	A30 / A40	PM.FA30	T.121	PM.K	PM.K1501
	K2	PM.FA108	T.101	PM.K	PM.K1496
	K34 / 15 / 18 / 32	PM.FA18	T.101	PM.K	PM.K1496
FISCHER PANDA	PSM6 / 8 / 10 / 12 PSM30 / 40	PM.35	T.107	PM.K	PM.K1503
FORD	2401	PM.FO2401	T.107	PM.K	PM.K1239
	2700	PM.FO1/2	T.107	PM.K	PM.K1239
	2704T	PM.FO3/4	T.107	PM.K	PM.K1239
	FORD LEMAN 120	PM.FO120	T.107	PM.K	PM.K1583
IVECO AIFO	CP3 / 8361	PM.I8300	T.106	PM.K	PM.K1250
	8061	PM.I8000	T.107	PM.K	PM.K1704
	8141	PM.I8141	T.107	PM.K	PM.K1583
	208 / 370 / 400	PM.INEF	T.177	PM.K	PM.K1438
KOLLER	3.5 / 4	PM.K0124	T.121	PM.K	PM.K1490
	VOIR TABLEAU SHERWOOD				
LOMBARDINI	LDW401	PM.15	T.121	PM.K	PM.K1456
	502 / 602 / 702 903 / 1003 / 1204	PM.V013	T.116	PM.K	PM.K1806
MAN	6.660E LE	PM.MA6660	T.107	PM.K	PM.K1704
	2866	PM.MA2866	T.162	PM.K	PM.K2866
	2840 / 42 / 48	PM.MA2840	T.115	PM.K	PM.K1840
	2842 / LONGUE	PM.MA2842	T.09820	PM.K	PM.K13165

POMPES EAU DE MER

MARQUE	TYPE MOTEUR	POMPE COMPLETE	TURBINE	KIT ETANCHEITE	KIT REPARATION
NANNI DIESEL	2.40 / 3.90 / 4110	PM.N2	T.101	PM.K	PM.K1495
	2.40 / 2.50	PM.N240	T.121	PM.K	PM.K1496
	2.60 / 3.90 DOUBLE	PM.N260C	T.101 X 2	PM.K	PM.K1495
	2.45 / 2.50 / 3.75	PM.N375	T.101	PM.K	PM.K1495
	3.100 / 4150 / 4195 / N3 / N4.38 / 4.40	PM.N4	T.106	PM.K	PM.K2503
	N.4180	PM.N4180	T.106	PM.K	PM.K1497
	5250DTI	PM.N5	T.106	PM.K	PM.K5250
	4.200 / 6.280	PM.N6	T.106	PM.K	PM.K1499
ONAN	5 / 6 / 7.5 / 9MDKOB	PM.ON102	T.121	PM.K	PM.K1496
	MDKLA	PM.ON103	T.121	PM.K	PM.K1490
	12 / 15 / 30MDJC /F/EC	PM.ON104	T.121	PM.K	PM.K1490
	MDKC / MDKD OBERDORFER	PM.ON202M	T.2052	PM.K	PM.K
PCM	TOUS	VOIR TABLEAU SHERWOOD			
PERKINS	PERAMA 20	PM.PM20	T.100	PM.K	PM.K1805
	M35 / M40	PM.PM35	T.101	PM.K	PM.K1495
	M25 / M30	PM.PM25	T.107	PM.K	PM.K2487
	M50 / M60 / M80	PM.PM50	T.106	PM.K	PM.K2503
	4108	PM.P4108J	T.107	PM.K	PM.K1503
	4108S	PM.P4108S	T.9959	PM.K	PM.KSH12221
	4236	PM.P4236	T.107	PM.K	PM.K1268
	6354 (3vis)	PM.P6354	T.106	PM.K	PM.K1250
	6354S	PM.P6354S	T.10615	PM.K	PM.K11068
	6354 CAZAUX	PM.P6354C	T.2015		
6354J	PM.P6354J	T.107	PM.K	PM.K1268	
VETUS	M2C5 M206	PM.VE125	T.101	PM.K	PM.K1987
	M2D5 M309	PM.VE125	T.107	PM.K	PM.K1987
	3.10 M205	PM.VE134	T.101	PM.K	PM.K1495
	P.4.14	PM.VE133	T.107	PM.K	PM.K1583
	DT43 / DTA43	PM.VE43	T.107	PM.K	PM.K1704
	DT64 / DTA64	PM.VE64	T.107	PM.K	PM.K1704
	DT67 / DTA67	PM.VE64	T.107	PM.K	PM.K1704
VOLVO DIESEL	2001 / 2002 / 2003	PM.V2002	T.121	PM.K22054	PM.K15756
	2003T	PM.VO2003T	T.107	PM.K22040	PM.K15757
	2010 / 2020	PM.VO2010	T.116	PM.K22160	PM.K1805
	2030 / 2040	PM.VO2040	T.116	PM.K22160	PM.K1805
	MD 5 / 7	PM.VO11	T.121	PM.K22054	PM.K1496
	MD 11 / 17 A BRIDE				
	MD 17	PM.VO17	T.116	PM.K22009	PM.K1809
	MD 21	PM.VO170	T.108	PM.K22047	PM.K15383
	MD 29 / 32	PM.VO32D	T.106	VO.875369	PM.K15540
	MD 1 A VISSER	PM.VOMD1	T.121	PM.K22054	PM.K15584
	MD 2 / MD 6 / MD 7				
	MD 22 A	PM.PM50	T.106	PM.K22053	PM.K2503
	MD 22 BLP	PM.VOD22	T.107	PM.K222180	PM.K22180
	MD 100 / 120A	PM.VOD100	T.135	PM.K	PM.K1579
	MD 40A GROS MODELE	PM.VO40A	T.105	PM.K10400	PM.K22137
	31 / 41 / 42 / 43 A EMBOUT	PM.VO41D	T.106	PM.K221360	PM.K1603
	31 / 41 / 42 / 43 TORIQUE	PM.VO41T	T.106	PM.K221360	PM.K1603
	TMD 60 / 70 ABC	PM.VO60D	T.106	PM.K45590	PM.K22590
	61 / 62 2 BRIDES	PM.VO6162	T.135	PM.K224220	PM.K22422
	61 / 62 1 PIECE	PM.VO6162BC	T.135	PM.K224220	PM.K22422

POMPES EAU DE MER

MARQUE	TYPE MOTEUR	POMPE COMPLETE	TURBINE	KIT ETANCHEITE	KIT REPARATION
VOLVO DIESEL	TD63	PM.VO63	T.162	PM.K224510	PM.K22451
	D2.55 / 75	PM.VOD275	T.107	PM.K22745	PM.K1745
	D3 FIXER	PM.VOD3F	T.178	PM.K221230	PM.K22123
	D3 PLATINE	PM.VOD3P	T.178	PM.K000	PM.K000
	D4 SORTIE ARRIERE	PM.VOD4A	T.144	PM.K000	PM.K22331
	D4	PM.VOD4	T.106	PM.K000	PM.K22332
	D6.F	PM.VOD6F	T.177	PM.K22631	PM.K2263
	D6.A	PM.VOD6	T.162	PM.K22632	PM.K000
VOLVO ESSENCE	100 / 110 / 120	PM.VO130	T.116	PM.K22009	PM.K22073
	130 / 115	PM.VO130	T.116	PM.K22009	PM.K22073
	B18 / B20	PM.VO130	T.116	PM.K22009	PM.K22073
	130 / 170	PM.VO170	T.108	PM.K15383	PM.K22047
	160 / 145 / 151	PM.VO170	T.108	PM.K15383	PM.K22047
	B230 / 171	PM.VO151	T.108	PM.K22072	PM.K15574
	V8 ANCIEN	PM.VOV8	T.107		PM.K22441
	NOUVEAU MODELE	VOIR TABLEAU VOLVO			
YANMAR	Y8 – Y12	PM.Y812	T.100	PM.K	PM.K3441
	1GM	PM.Y1GM	T.113	PM.K	PM.K3442
	2GM - 3GM	PM.Y2GM	T.100	PM.K	PM.K3445
	3HM	PM.Y3GMFR	T.129	PM.K	PM.K3443
	2QM / 20 / 30	PM.Y2QM	T.129	PM.K	PM.K3446
	2QM15	PM.Y2QM15	T.100	PM.K	PM.K3447
	4JH	PM.Y4JH2	T.107	PM.K	PM.K3448

POMPE	TURBINE	KIT REPARATION	JOINT	VIS DE COUVERCLE	ETANCHEITE	CAME	ROULEMENT	ARBRE	PLAQUE USURE	COUVERCLE	VIS DE CAME VI.	CLIPS
PM.15	T.121	K4456	2403	233 (4)	15996	2372	6001 (2)	2696		2400	5397	
PM.16	T.3342	K.2502	15244	233 (6)	2578 X2	2577	6002 (2)	2594		2390	2590	
PM.BUDV24/48	T.107		15244	233 (6)	15247 (2)		6203 (2)	01-45320		1106		
PM.36	T.106	2800	15275	1141 (6)	244	2439	6204 (2)	2439		2408	2423	
PM.38	48380001	2504	0160	5397 (4)	15996	2391	6001 (2)	2466		2467	5397	
PM.40F												
PM.BE122	T.100	K.2805	2360	233 (6)	2401 X2	2372	6001 (2)	2372	1765	2380	5396	2377 (2)
PM.BM101	T.121	K.2496	2369	233 (4)	15996 (2)	2372	6001 (2)	3369	1765	2370	5397	2377 (2)
PM.BM3550	T.101	2495	15385	233 (6)	15996 (2)	2381	6001 (2)	3606	1765	2380	233	2377 (2)
PPM.BUDV10	T.121	2496	2369	233 (4)	15996 (2)	2372	6001 (2)	2376	1765	2370	5396	2377 (2)
PM.BUDV20	T.116	2496	2369	233 (4)	15695 (2)	2372	6001 (2)	3322	1765	2370	5396	2377 (2)
PM.CA3116	T.17000K	23975										
PM.CA3208J	T.135											
PM.CA3208S	T.17000K	23975										
PM.CH6470												
PM.CHD05	T.10315K	11430	10931	1482	10927	10944	4257 (2)	11429A			10515	
PM.CU504	T.107	KCU504	15275		22617	2411	3205	CU504	2413	2428		
PM.DD6V53	T.135		2367									
PM.DD6V71	T.135		2367									
PM.DD8V53	T.135		2367									
PM.DD8V71			2367									
PM.DD8V92			2367	2419						2419		
PM.FA109	T.121	2496	2369	233 (4)	15996 (2)	2372	6001 (2)	1786	1765	2370	5396	2377 (2)
PM.FA18	T.122	2496	2369	233 (4)	15996 (2)	2372	6001 (2)	2746	1765	2370	5396	2377 (2)
PM.FAK34	T.121	2496	2369	233 (4)	15996 (2)	2372	6001 (2)	2746	1765	2370	5396	2377 (2)
PM.FAL30	T.121	2502	2403	233 (4)	15996	2372	6001 (2)	1476	1765	2400	5397	
PM.FO120	T.107	SK33	15244	2423 (6)	2723 (2)	3729	6002 (2)	A.FL		2390		
PM.FO2401												
PM.FORD	T.107	SK239	15244	2423 (6)	2723 (2)	3729	6203 (2)	AF.L	2395	2390		
PM.I150	T.106	2500	15275	1141 (6)	1141 (6)	2411	3204	2407	2413	2408	2565	

POMPES EAU DE MER

POMPE	TURBINE	KIT REPARATION	JOINT	VIS DE COUVERCLE	ETANCHEITEE	CAME	ROULEMENT	ARBRE	PLAQUE USURE	COUVERCLE	VIS DE CAME VI.	CLIPS
PM.I8060	T.107	3704	15275	1141 (6)	15247	2411	6303 (2)	3731	2413	2408	5395	
PM.I8141	T.107	3745	15244	233 (6)	15247 (2)	2393	6003 (2)	3507	2395	2390	5395	
PM.I8200												
PM.I8300												
PM.	T.177				74591	3643				4016		
PM.JO144	T.101	2495	13385	233 (6)	15996 (2)	2381	6001 (2)	1760		2380	233	2377 (2)
PM.KK2620	T.116											
PM.KO124												
PM.LU145	T.106	2499	15275	1141 (6)	2391	2411	6203 (2)	3194	2413	2408	5395	
PM.M6660	T.107	3704	15275	1141 (6)	15247	2411	6303 (2)	A6660	2413	2408		
PM.ME170	T.107	3745	15244	233 (6)	15244	2393	6202 (2)	3652	2395	2390	1141	
PM.ME240	T.107	2497	15244	233 (6)	2391	2393	6002 (2)	2 MONT	2395	2390	5408	
PM.N230	T.101	2495	13385	233 (6)	15996 (2)	2381	6001 (2)	2382		2380	5396	2377 (2)
PM.N438	T.107	3745	15244	233 (6)	15247	2393	6202 (2)	3367	2395	2390	5395	
PM.N4	T.107	3745	15244	233 (6)	15247	2393	6202 (2)	2 MONT	2395	2390	5395	
PM.N174												
PM.N2	101	2495	15385	233 (6)	15996 (2)	2381	6001 (2)	2378		2380	233	
PM.260C												
PM. N375	101	2495	15309	233 (6)	15996 (2)	2381	6001 (2)	3494		2380	233	2377 (2)
PM.N4180	107	2497	15244	233 (6)	2391	2393	6002 (2)	2 MONT	2395	2390	5408	
PM.N5	906	5069	15275	1141 (6)	15247	5687	6203 (2)	5687	2413	2408	1141	
PM.N6	T.106	2499	15275	1141 (6)	2391	2411	6203 (2)	3359	2413	2408	1141	
PM.ON102	T.121	2496	15275	233 (6)	15996 (2)	2372	6001(2)	3289	1765	2370	2397	2377 (2)
PM.ON103	T.121	2490	15994	233 (3)	2546	2372	6001(2)	2698	1765	1870	5394	

POMPE	TURBINE	KIT REPARATION	JOINT	VIS DE COUVERCLE	ETANCHEITE	CAME	ROULEMENT	ARBRE	PLAQUE USURE	COUVERCLE	VIS DE CAME VI.	CLIPS
PM.ON104	T.121	2490	2360	233 (3)	2546	2372	6001(2)	3180	1765	1870	5394	
PM.ON202M	6593	11679	SUR DEMANDE									
PM.41080	T.107	24880114	15244	233(6)	2723 x 2	2393	3202	AP41080		2390	5408	
PM.P4108J	T.107	2497	15244	233(6)	2391	2393	6002(2)	(2)	2395	2390	5408	
PM.P4108S	9959	SK12221	11360	10515(6)	10514	10072	6205 5/8 (2)	12444		11389	10515	
PM.P4154JAB	T.107	SK11702	SUR DEMANDE									
PM.P4154S	T.103	12980	TO	11797	12981	10627	62025/8	13272			10515	
PM.P4236	T.107	SK260 :01	15244	1556(6)	22708	3729	6202 (2)	PA4236	2395	2390	2414	4258 x 1
PM.P6354.4	T.106	2500	15275	2414 (6)	6080	2411	3204	2407		2408	5395	4258 x 1
PM.P6354CAZAU	PLUSIEURS MONTAGES AU MODELE											
PM.P6354J à bride	T.106	SK268	15244	1556	22617	2393	6202 (2)	24880122	2395	2390	2414	
PM.P6354S	T.120	11068	10931	10515 (6)	10927	10944	6202 5/8	11374		10182	10515	
PM.PM20	T.100	2805	2360	233 (6)	2401 (2)	2372	6000(2)	1104	1765	1106	5830	2589 (2)
PM.PM25	T.101	2487	15385	233 (6)	15996 (2)	2381	6001 (2)	3738		2390	5394	
PM.PM35	T.101	2498	15385	233 (6)	15996 (2)	2381	6001 (2)	2732		2380	5396	2377 (2)
PM.PMD22	T.107	3745	15244	233 (6)	15247 (2)	2393	6303 (2)		2395	2390	5395	

TYPE	TURBINE	ROULEMENT	CYCLAM	GLACE	PLAQUE INTERNE	BAGUE AVANT	BAGUE ARRIERE	AXE	PM E/S
RC5D / RC8D	48380001	48112023 (2)	48418040		95800009			95402404	PM.RC8D
BD1 RC6	48380001		95402390		95800007			95402388	PM.RC6
RC7/9/11 RC12D	48380001	48112023 (2)	48418040		95800007			95402404	PM.RC12D
RC16D1	48380004		908200269		908200278			908200277	PM.RC16D1
RC16D2	48380004		908200349		908200328			908200327	PM.RC16D2
BD2 RC15E / RC30D	48380002	48112021 (2)	48418040 (2)	48418041 (2)	95800003	95802015	95802015	95402356	PM.RC30D
RC28D / 30D petite	48380001	48112021 (1)	48418040		95800009			95402439	PM.RC28D
RC4130A	48380001	48112039	48418040		95800009			95402398	Gros PM.RC4130A
RC4130R	48380001	48112039	48418040		95800009			95402448	Petit PM.RC4130R
RC20-25-40-35-E	48380001	48112023(2)	48418040		95800007			95402404	PM.RC25E
RC35C / 90DS	2015 x 2	970303940	15253 52°					PM.A155MS	PM.RC35C
RC140DS / 160D	48380002	48112021 (2)	48418040 (2)	48418041 (2)	95800001	95802015	95802015	95402382	PM.RC140DS
RC145DTS 130 RC210DTS 240	48380003	48112022 (2)	48418040 (2)	48418041 (2)	95800001	954802027	95802015	95402405	PM.RC240DTS
RC80 / 140DF	48380002	48112021 (2)	48418040 (2)	48418041 (2)	95800003	95802015	95802015	95402382	PM.RC140DF
RC180 / 210 DF	48380003	48112021 (2)	48418040 (2)	48418041 (2)	95800003	95802027	95802015	95402405	PM.RC210DF

JOINT DE POMPE 48438068



ENTRAINEMENT 481000067



BAGUE ENTRAINEMENT 95402357

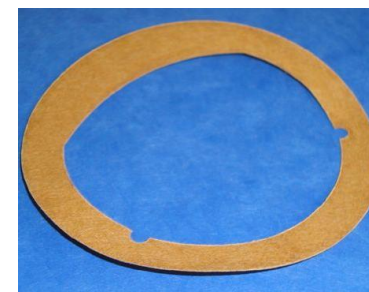

POMPE	TURBINE	KIT REPARATION	JOINT	VIS DE COUVERCLE	ETANCHEITE	CAME	ROULEMENT	ARBRE	PLAQUE USURE	COUVERCLE	VIS DE CAME VI.	CLIPS
PM.VE125	T.101	3987	160	233 (6)	2721	3832	6001 (2)	3833		2390	5394	2377 (2)
PM.VE133	T.116	2495	15385	233 (6)	15996 (2)	2381	6001 (2)	1760		2380	233	2377 (2)
PM.VE134	T.101	2495	15385	233 (6)	15996 (2)	2381	6001 (2)	1760		2380	233	2377 (2)
PM.VE136	T.101	2495	15385	233 (6)	15996 (2)	2381	6001 (2)	2598		2380	5396	2377 (2)
PM.VM36	T.106	2499	15275	1141 (6)	2391	2411	6203 (2)	2384	2413	2408	5395	
PM.VM42	T.106	2499	15275	1141 (6)	2391	2411	6203 (2)	2384	2413	2408	5391	
PM.VO2040	T.106	2495	15244	233 (6)	15996 (2)	2381	6001 (2)	5711		2390	15693	2377 (2)
PM.VO11	T.121	2496	15994	233 (4)	515996 (2)	2372	6001 (2)	2376	1765	2370	5396	2377 (2)
PM.VO130	T.121	2809	15994	233 (6)	515996 (2)	2381	6001 (2)	2376		2380	5396	2377 (2)
PM.VO151	T.107	15574	2365	154 (2)	15247	3729	834524 (2)	5670			1141	
PM.VO17	T.116	2809	15994	233 (6)	15247	2381	6001 (2)	2379		2380	5396	2377 (2)
PM.VO170	T.108	15383	15994	2414 (6)	15247	2393	864524 (2)	6066	2395		1141	
PM.VO2002	T.121	15756	2369	2414(4)	15247	3433	6001 (2)		1765	2370	1141	
PM.VO2003T	T.107		2369	2414 (4)	15247	3729	6203 (2)		1765	2370	1141	
PM.VO2010	T.100	2805	2360	233 (6)	15224	2372	6000 (2)	1104	1765	1106	5830	
PM.VO40DA gros	T.105	22137	2362	1393 (6)	25527 (2)		6305 (2)	A3718	875769	2422	1414	2377 (2)
PM.VO41T	T.106	3603	3603	1141 (6)	15247 (2)	2411	6203 (2)	3363	2411	2408	1414	2377 (2)
PM.VO41D	T.106	3603	3603	1141 (6)	15247 (2)	2411	6203 (2)	3363	2413	3364	5410	
PM.VOD2	T.107	5893	TRIANGLE	1141 (4)			6303 (2)			3712		
PM.VO60D	T.106		15275	1141 (8)	22708	2411	6206 (2)	826250	2413	2408		

POMPE	TURBINE	KIT REPARATION	JOINT	VIS DE COUVERCLE	JOINT SPY	CAME	ROULEMENT	ARBRE	CALE	COUVERCLE	VIS DE CAME	CLIPS
PM.VO62	T.105		2362	1149 (6)	16407		6206 x 2		2422	2419		
PM.VO7												
PM.VO70D	T.106		15275	1141 (6)	16407	2411	6206 x 2	826250	2413	2408		2412
PM.VO7V	T.121	2496	2369	233(4)	15996 (2)	2372	6001 x 2	3322	1765	2370	5396	2377
PM.VOD275	T.107	3745	3683809	233 (4)	51466		6303 x 2	5894	2395	2400		
PM.VOMD1	T.121	15584	15394	1599a (4)	15996 (2)	3433	Bague pr			2370	5396	
PM.VOMD22	T.107		15244	233 (6)	15247	2393	6302 (2)	4579		2390		
PM.VOV8	T.107		2365	15693 (6)	722081		6007			4970		
PM.VOV8N	T.107		2365	15693 (6)	722002		6203			4970		
PM.Y1GM	T.113											
PM.Y2GM	T.100											
PM.Y2/3GMFR	T.120											
PM.Y2QM20	T.100											
PM.Y4JH2	T.107											
PM.Y4JH3E	T.107											
PM.Y4LH	T.107											
PM.YS8.12	T.100											

Pompe et accessoires de pompe CAZAUX

TURBINE	
T.2015	1520
T.2017	17

VOLVO

POMPES EAU DE MER

21212798

3.0GLP-D / 3.0GLP-E
3.0GLP-J / 3.0GLP-N

R.O 21212798

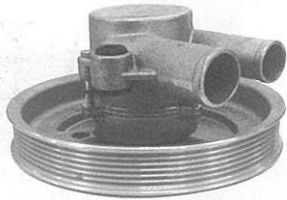

21212801

3.0GXIC-J
3.0GXIJ

R.O 21212801



21214595

3.0GPL-A, B, C
3.0GLM-A, B, C
3.0GSP- A, B, C
3;0GSM- A, B, C

R.O21214595

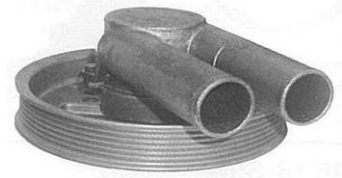

21212799

4.3GL-G, 4.3GL-GF, 4.3GXI-F, 4.30SI-F
4.3GXI-GF, 4.30SI-GF, 4.3GXI-G, 4.30SI-G
5.0GL-M, 5.0GL-HI, 5.0GXI-F, 5.0GXI-FF, 5.0OSI-FF
5.0GGXI-G, 5.0GXI-GF, 5.0OSI-G, 5.0SI-GF, 7.0GIF-FF
5.7GXI-G, 5.7GXI-GLI, 5.7OSI-E, 5.7OSI-EF, 5.7OSI-GF
5.7SXI-G, 5.7SXI-GF, 5.7GI-F
5.7GXIL-G, 5.7GIL-G,
5.7GXIL-H

R.O 21212799

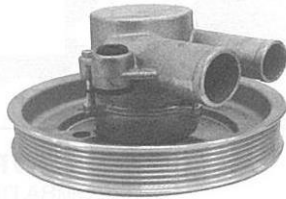

21214599

3.0GSMEFS, 3.0GSPEFS
4.3GXI-C, 4.3GXI-CF, 4.3GXI-D, 4.3GXI-DF, 4.3GXI-SI
4.3GXI-E, 4.3GXI-EF, 4.3OSI-E, 4.3OSI-EF
5.0GXI-C, 5.0GXI-CF, 5.0GXI-D, 5.0SI-C, 5.0SI-CF,
5.0SI-D, 5.0SI-DF, 5;0SI-E, 5.0GXI-EF, 5.0DSI-E, 5.7GI
5.7GXI, 5.7OSI, 5.7SXI, 5.7GXIL

R.O 21214599

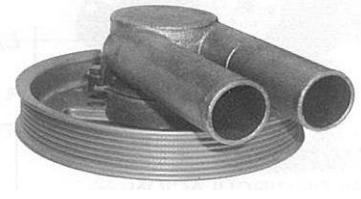

21255090

4.3GL-E, GL-EF
5.0GL-F, GL-FF

R.O21255090

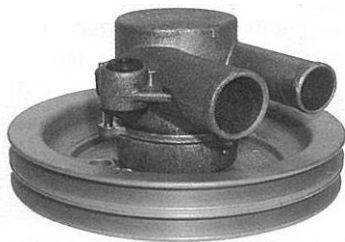

21214596

4.3GL-A, GL-B, GL-C, GL-D
5.0GL-A, GL-B, GL-C
5.0GL-D, GL-E
5.7GL-A, GL-B, GL-C
5.7GL-D, GL-E

R.O21214596

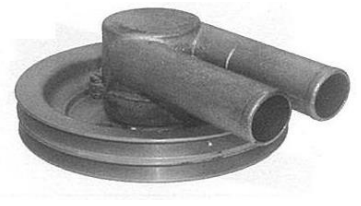

PM.SHG9903

3.0BY, MD, HU, LK, NC, WT
4.3LK, NC
5.7LK, NC
7.4LK, NC

R.O3857794





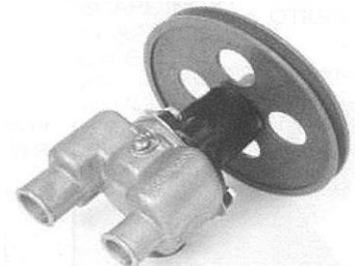

PM.SHG9901

4.3MD, HU
5.0 Ford HU, MD, NC
5.7HU, MD, NC
5.8 Ford NC
7.4HU, MD
8.2MD

R.O 3858847

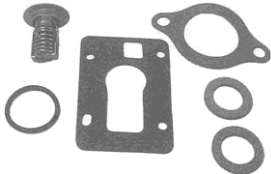

THERMOSTATS OMC / VOLVO / MERCURISER

THERMOSTATS & KITS				
SDM13430 KIT THERMOSTAT OMC RO : 383307 160° F 	SDM13440 KIT THERMOSTAT OMC 4 CYL GM - 181 RO : 982554 	SDM13028 KIT THERMOSTAT OMC 7.4 L / 8.2 L RO : 3853983 140° F 		
SDM13370 KIT THERMOSTAT 4/6 CYL. 140° BLOC GM 	SDM13390 KIT THERMOSTAT GM V6/V8 140° 	SDM13380 BLOC FORD V8 140° 		
SDM13101 NOUVEAU V6 & V8 160° 	SDM13420 KIT THERMOSTAT 6 CYL. 470 / 480 / 3.7 L RO : 99155T2 	SDM13400 KIT THERMOSTAT ET JOINTS 4 CYL 224 / 3.7 L RO : 76270T1 		
Modèles	Cyl.	Année	Degré	Réf. kit thermostat
90	L4	1970	160°	SDM13430
100	L4	1972 / 73	160°	SDM13430
2.5 L	153 / L4	1982 / 88	160°	SDM13440
120	153 / L4	1969 / 80	160°	SDM13430
120	153 / L4	1980 / 81	160°	SDM13440
140	181 / L4	1973 / 80	160°	SDM13430
3.0 L	180 / L4	1982 / 88	160°	SDM13440
3.8 L	V6	1981 / 85	160°	SDM13430
175	V6	1975 / 77	160°	SDM13430
262	262 / V6	1989	160°	/
4.3 L	262 / V6	1985 / 86	160°	SDM13430
4.3 L	262 / V6	1989 / 92	160°	/
4.3 L	262 / V6	1994 / 97	140°	SDM13028
155	/	1969 / 72	160°	SDM13430
165	/	1972 / 76	160°	SDM13430
170	/	1974	160°	SDM13430
185	V8	1978 / 80	160°	SDM13430
190	V8	1974 / 77	160°	SDM13430
200	V8	1979 / 81	160°	SDM13430
210	V8	1969 / 72	160°	SDM13430
215	V8	1971	160°	SDM13430
225	V8	1971	160°	SDM13430
230	V8	1979 / 81	160°	SDM13430

THERMOSTATS OMC / VOLVO / MERCUISER

Modèles	Cyl.	Année	Degré	Réf. kit thermostat
AQ175A	V6 / 229	1981 / 85	62°	SDM13381
430A / B	V6 / 262	/	62°	SDM13381
431A / B	V6 / 262	/	62°	SDM13381
AQ205A	V6 / 205	1988	62°	SDM13381
AQ190A	V8 / 302 FORD	1976 / 77	62°	SDM13381
AQ200B	V8 / 305	1969 / 74	62°	SDM13381
AQ200C	V8 / 305	1976 / 77	62°	SDM13381
AQ200D	V8 / 305	1977 / 86	62°	SDM13381
AQ200F	V8 / 305	1985 / 86	62°	SDM13381
AQ211A	V8 / 305	1986	62°	SDM13381
AQ225B	V8 / 305	1974 / 76	62°	SDM13381
AQ225D	V8 / 305	1977 / 86	62°	SDM13381
AQ225C	V8 / 305	1976 / 77	62°	SDM13381
AQ225E / F	V8 / 305	/	62°	SDM13381
AQ500A	V8 / 350	/	62°	SDM13381
AQ231A	V8 / 305	1986	62°	SDM13381
AQ240A	V8 / 350	1976 / 77	62°	SDM13381
AQ260A	V8 / 350	1978 / 85	62°	SDM13381
AQ270A / B / C / D	V8 / 350	1986	62°	SDM13381
AQ501A	V8 / 350	/	62°	SDM13381
AQ501B	V8 / 350	/	62°	SDM13881
AQ255A	V8 / 350	1977 / 78	62°	SDM13381
AQ255B	V8 / 350	1978	62°	SDM13381
AQ280A	V8 / 350	1978 / 79	62°	SDM13381
AQ290A	V8 / 350	/	62°	SDM13381
3.0L GL / GS	4L / 181	/	160°	SDM13070
4.3L GL / GS / GI	V6 / 262	/	160°	SDM13028
5.0L FL / FI	V8 / 305	/	160°	SDM13028
5.7L GI / GL	V8 / 350	/	160°	SDM13028
5.8L FL / FI	V8 / 351	/	160°	SDM13028
5.8L FSI	V8 / 351	/	160°	SDM13028
7.4L GI / GL / GSI	V8 / 454	/	160°	SDM13028
7.4L GI L29	V8 / 454	/	140°	SDM13028
8.2L GL / GSI	V8 / 502	/	140°	SDM13028

POMPES ET TURBINES SHERWOOD

Moteur	Référence constructeur	Référence Sherwood	Référence turbine	Référence kit mineur	Référence kit majeur	Référence cyclam	Référence roulement
CATERPILLAR							
3208	9Y1304	P176X	17000K	23973	23975	15955	(2) 15951
3208	7E4115	P176X	17000K	23973	23973	23799	(2) 15951
3116	7 ^E 3268	P1710X	17000K	23973	23975	15955/15950	(2) 15951
3116	4P7168	P1710X	17000K	23973	23973	23799/21776	(2) 15951
3126	113-1109	P1726X	17000K	23973	23975	15955/21776	(2) 15951
3126	152-8392	P1726TCX	17000K	/	/	23799/21776	(2) 15951
3126	170-6116	P1732X	17000K	13973	23975	23799/21776	(2) 15951
3176	123-0500	G1805	18000K	24023	24024	19878/19869	24000*
3196	123-0471	G1807	18000K	24023	24024	19878/19869	24001*
3196	197-1328	G18071-01	18000K	24023	24024	23837/19869	24001*
3406C	201-0956	G18061-01	18000K	24004	24006	23837/19869	24001*
3406E	196-8895	G18081-01	18000K	24004	24007	23837/23045	24002*
CRUSADER							
220/270/300/350	97179	E35	10615K	10999	11068	10927	4257
INTERCEPTOR	/	R50G	09959K	/	/	10927	4257
220/270/300/350	/	E35	10615K	10999	11068	10927	4257
220/270/300/350	40050	P101	10615K	19301	19300	12859	(2) 23448
CUMMINS							
210 CV 4B	3912019	M71	10615K	23976	23977	12859/10514	(2) 23448
250 CV Serie B	3912962	GC1	15000K	23980	23981	12859/10514	(2) 23448
6B 250CV 4B CEPC	1920298	GC5	15000K	23980	23981	12859/10514	(2) 23448
6B 250CV 4B CEPC	3927684	GC5	15000K	23980	23981	12859/10514	(2) 23448
6B	3919899	P1716X	17000K	23972	23974	15955/19674	(2) 15951
6B	3922590	P1716X	17000K	23972	23974	15955/19674	(2) 15951
6C/6B/ 270-450 CV	3912139	P1722X	17000K	23972	23974	15955/19674	(2) 15951
6C	3922589	P1722X	17000K	23972	23974	15955/19674	(2) 15951
6C/6B/ 270-450 CV	3897194	P1727X	17000K	23972	23974	15955/19674	(2) 15951
6C/6B/ 270-450 CV	3866493	P1730X	17000K	23972	23974	15955/19674	(2) 15951
6C	4003526	P1730X	17000K	23972	23974	15955/19674	(2) 15951
QSM11	3349392	G1810	18000K	24005	24008	23512	/
KOHLER							
FORD	344089	G907P	09000K	/	/	22546	(2) 23448
4/6.5KW Essence	344371	G907	09000K	/	/	18035/10926	(2) 23448
5/7KW Diesel	359341	GP8001	8000K	/	/	23459	(2) 23323
MERCUISER							
7.3 DIESEL	L / 270	G151	15000K	23980	23981	12859	(2) 23448
7.3 DIESEL	L / 270	G155	15000K	23980	23981	12859	(2) 23448
ONAN							
4 CYL DIESEL	132-0275	K75B	09959K	23979	12665	12859	(2) 23448
4 CYL DIESEL	132-0276	K75B	09959K	23979	12665	12859	(2) 23448
5 CYL DIESEL	132-0278	L10B	10615K	23976	23977	12859	(2) 23448
5 CYL DIESEL	132-0278	L10B	10615K	23976	23977	12859	(2) 23448
5 CYL DIESEL	132-0343	G1006	10615K	10615K	22014	21208/21209	(2) 23448
OMC							
IN BORD	981939	G46	10615K	23976	23977	12859	(2) 23448
V8	981937	H85	10615K	23976	23977	12859	(2) 23448
V8	985096	G46	10615K	23976	23977	12859	(2) 23448
6 / 8 CYL	3852398	G9901	06659K	23979	12665	12859	(2) 23448
4 CYL	3852399	G9903	09959K	23979	12665	12859	(2) 23448
4 CYL	3855079	G9903	09959K	23979	12665	12859	(2) 23448