

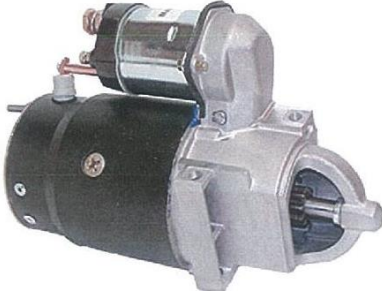

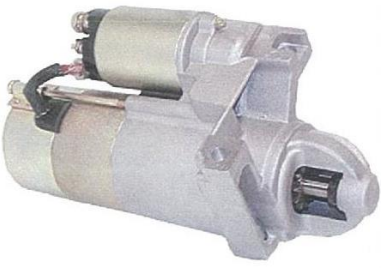

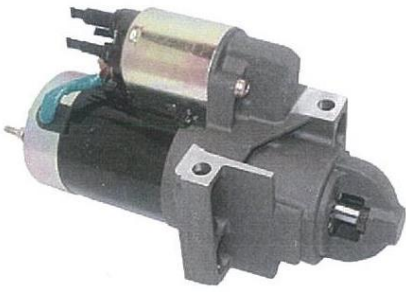



CHAPITRE III

DEMARREURS ALTERNATEURS MOTEURS DE RELEVAGE ALLUMAGE

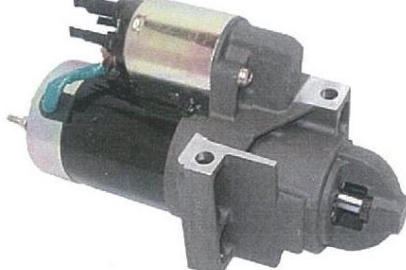
Pages 39 à 53

ELECTRICITE

DEMARREUR GM FORD		
<p>SDM74150 DEMARREUR VIS DROITE</p> 	<p>SDM74140 DEMARREUR VIS DECALEE</p> 	<p>D.172 DEMARREUR A REDUCTEUR 4 cyl VIS DROITE</p> 
<p>D.174 DEMARREUR A REDUCTEUR VIS DECALEE</p> 	<p>D.5275M DEMARREUR SUR CLOCHE</p> 	<p>D.5075M DEMARREUR FORD</p> 
	<p>D.5275ML DEMARREUR CONTRE ROTATION</p>	<p>D.5075ML DEMARREUR FORD CONTRE ROTATION</p>
<p>D.338M DEMARREUR FORD 2.3L & 5.8L FORD</p> 	<p>D.178 DEMARREUR A REDUCTEUR VIS DECALEE VOLANT 14 "</p> 	<p>D.70112 MODELE OMC 7.4L</p> 
<p>SDM72450 SOLENOIDE POUR D.174 / D.172 / D.178</p> 	<p>SDM72460 SOLENOIDE DELCO REMY LONGUEUR 9,5 CM</p> 	<p>SDM72490 SOLENOIDE DELCO REMY LONGUEUR 7,5 CM</p> 

ELECTRICITE

MOTEURS DE TRIM & RELAIS

D.1088M

MOTEUR DE TRIM COMPLET
RO 14336A20 / 14336A8 /
88183A12



D.1087M

MOTEUR DE TRIM
R.O 17649A1 / 87828



D.0001

RESERVOIR DE TRIM
R.O 18525A1



D.0002

RESERVOIR DE TRIM 4 VIS
R.O 88316A1

SDM72380

RELAIS
R.O 89-818999A2



SDM72360

RELAIS
R.O 87-76416A1



SDM72370

RELAIS DE TRIM
R.O 89-68258A4 / 89-853654A1



SDM72390

RELAIS DE DEMARRAGE
R.O 89-96054T



SDM72400

RELAIS DE TRIM
R.O 89-96158T



SDM72410

RELAIS
R.O 65057T1



SDM72480

RELAIS
R.O 25661T1

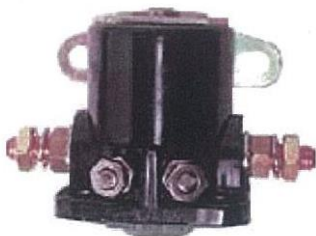

SDM72371M

RELAIS
R.O 89-818997T1



SDM72372M

RELAIS
R.O 89-818864T



ELECTRICITE

MOTEURS DE TRIM & RELAIS

D.1081M

MOTEUR DE TRIM 3 FILS
R.O 982058



D.1085M

MOTEUR DE TRIM
R.O 382138



D.1086M

MOTEUR DE TRIM
2 CONNECTIONS
R.O 393259



D.3108

MOTEUR TRIM 3 CONNECTIONS
POUR EMBASE SUR 2.5L, 3.0L
DE 1979 A 1985
R.O 982069



D.3117

MOTEUR DE TRIM
R.O 986280



D.6206

MOTEUR TRIM 3 CONNECTIONS
R.O 387277



D.1089

MOTEUR TRIM COMPLET
R.O 3586765



D.3117

MOTEUR TRIM SX
R.O 3853945



D.6223

MOTEUR POUR TRIM MECANIQUE
R.O 850834-3



D.6224

MOTEUR TRIM COMPLET
R.O 852928-1



D.6232

MOTEUR DE TRIM
HYDRAULIQUE
R.O 854525-3



D.0001

RESERVOIR TRIM 1 VIS
R.O 854531-1



D.0002

RESERVOIR TRIM 4 VIS
R.O 3861570

ELECTRICITE

RELAIS ET FUSIBLES

SDM73030

12V, 30 AMP
115, 130, 165
MD1, MD21, MD71
RO 241812, 870670,
876038, 1324492, 7737784

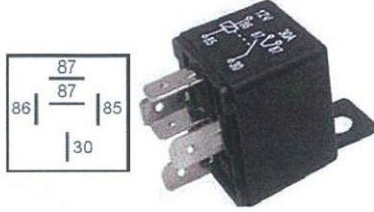

SDM73020

12V, 30 AMP.
2010, 2020, 2030, 2040
30, 31, 40, 41, 42, 102 y V8
R.O 879367, 876037

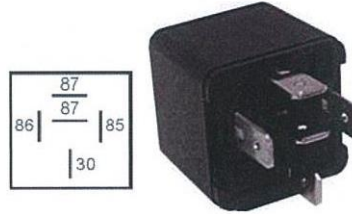

SDM73040

12V, 30 AMP.
131, 145, 175, 250
V8, TMD30, TMD40
R.O 876040

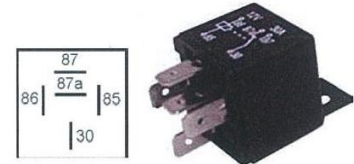

SDM73050

12V, 30 AMP.
V6, V8, 2001, 2002, 2003
AQ125B, 131A-B-C-D,
145B, 151 A-B-C
R.O 841177

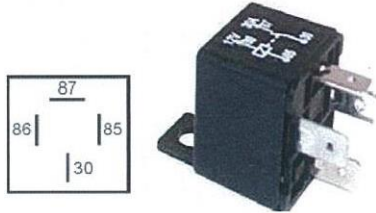

SDM73010

12V, 30 AMP.
MD22, 63, 71, 73, 74
30, 40, 61, 70 y V8
R.O 831725, 876039

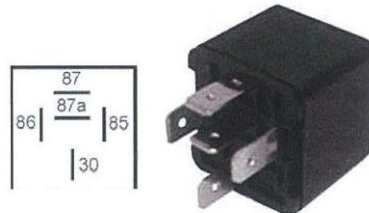

SDM73065

AQD30, 31, 40, 41
AQ131A-B-C-D
AQ145A-B, 151A-B-C, 171A-C
175A, 205, 231, 260
R.O 852565-1



MP1140004

FUSIBLE THERMIQUE
MOTEUR 50 AMP.

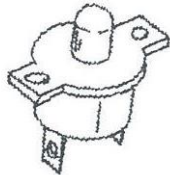

MD.1140005
FUSIBLE 60 AMP.

SDM72420

RELAIS
R.O 388444



SDM72480

RELAIS
R.O 25661T1



SDM72360

RELAIS
R.O 87-76416A1

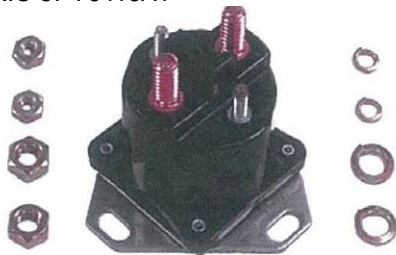

ELECTRICITE

TETES D'ALLUMEUR

SDM71650
VORTEC V6 MPI
R.O 888731



SDM071430
VORTEC V8 MPI
R.O 884792



SDM71400
DELCO V8
R.O 808483T



SDM71410
DELCO V6
R.O 850484T



SDM71420
DELCO 4 YL
& 3.0LX
R.O 811635T



SDM71500
MERCURISER V6
R.O 13753A2/815407A2



SDM71540
DELCO 4 CYL.
R.O 393-9459



SDM71550
AUTOLITE V8
R.O 393-4988



SDM71510
MERCURISER V8
R.O
16457A4/
805759A2



SDM71520
DELCO V8
R.O 383587



SDM71530
DELCO 6 CYL.
R.O 980152



SDM71560
PRESTOLITE
V8
R.O 984401



SDM71570
PRESTOLITE V8
R.O 982336



SDM71580
MALLORY V8
CYL.
R.O 382133



SDM71590
MALLORY
V8
R.O 984401



















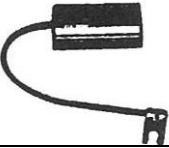
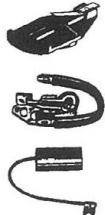

SDM71600
PRESTOLITE
V6
R.O 984398

















SDM71640
FORD 302 / 351









ELECTRICITE

ALLUMAGE				
MALLORY V8 TETE BASSE			MALLORY STANDARD V8	
N° 71580 ALLUMEUR 			N° 71590 ALLUMEUR 	
N° 71090 ROTOR 			N° 71040 ROTOR 	
N° 70060 RUPTEUR 			N° 70060 RUPTEUR 	
N°70580 CONDENSATEUR 			N°70580 CONDENSATEUR 	
N°72680 KIT : SDM71060 SDM70010 SDM70510 			N°72620 KIT : SDM71060 SDM70010 SDM70510 	
ALLUMEUR	ROTOR	RUPTEUR	CONDENSATEUR	KIT ALLUMAGE
4 CYL. N°71540 	4 CYL. N°71020 	4 CYL. N°70020 	4 CYL. N°70530 	4 CYL. N°72610 
6 CYL. N°71530 	6 CYL. N°71020 	6 CYL. N°70020 	6 CYL. N°70530 	6 CYL. N°72610 

ELECTRICITE

ALLUMAGE		
V6 PRESTOLITE	V8 PRESTOLITE A VISSER	V8 PRESTOLITE A CLIP
<p>N° 71600 ALLUMEUR</p> 	<p>N° 71560 ALLUMEUR</p> 	<p>N° 71570 ALLUMEUR</p> 
<p>N° 71060 ROTOR</p> 	<p>N° 71060 ROTOR</p> 	<p>N°71050 ROTOR</p> 
<p>N° 70010 RUPTEUR</p> 	<p>N° 70010 RUPTEUR</p> 	<p>N° 70010 RUPTEUR</p> 
<p>N°70510 CONDENSATEUR</p> 	<p>N°70510 CONDENSATEUR</p> 	<p>N°70510 CONDENSATEUR</p> 
<p>N°72650 KIT :</p> <p>SDM71060 SDM70010 SDM70510</p> 	<p>N°72650 KIT :</p> <p>SDM71060 SDM70010 SDM70510</p> 	<p>N°72660 KIT :</p> <p>SDM71050 SDM70010 SDM70510</p> 

ELECTRICITE

KITS CONVERSION ELECTRONIQUE		
<p>SDM72510 4 CYL</p> 	<p>SDM72520 V8 MALLORY YL / YD</p> 	<p>SDM72530 PRESTOLITE V8</p> 
<p>SDM72540 PRESTOLITE V8</p> 	<p>SDM72570 DELCO 6 CYL</p> 	<p>SDM72550 PRESTOLITE 4 CYL.</p> 
Référence	Désignation	
SDM72510	Kit conversion électronique 4 cyl. GM	
SDM72520	Kit conversion électronique V8 Mallory	
SDM72530	Kit conversion électronique V8 Prestolite tête vis	
SDM72540	Kit conversion électronique V8 Prestolite	
SDM72550	Kit conversion électronique Prestolite 4 cyl.	
SDM72570	Kit conversion électronique Delco 6 cyl.	
SDM72500	Kit conversion électronique V6 Prestolite	

ELECTRICITE

BOBINES

SDM72110

RESISTANCE EXTERNE
R.O 38547 / 32193A2 / DELCO
1115202



SDM72112

120 / 140 / 2.5L
3.0L / 3.0LX
R.O 15071T

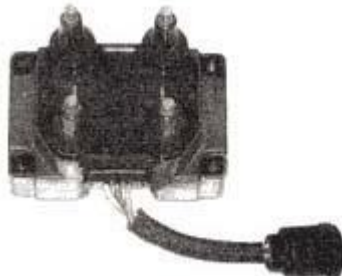

SDM72113

R.O 3854002-7, 3854922-6

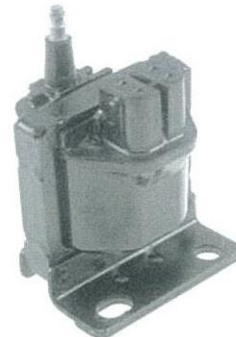

SDM72114

R.O 806673T1



SDM72115

R.O 392-7803A4 /
392-805



SDM72130

R.O 3854001



SDM73110

R.O 87-91019A3



SDM73120

R.O 87-91019A6 / 87-861780A2



SDM73190

R.O 3854003

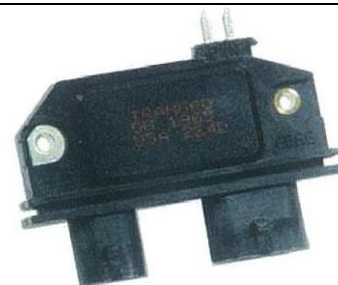

ELECTRICITE

MODULES D'ALLUMAGE

SDM73190

MODULE 4 CYL. ET V8
R.O 3854003



SDM72140

MODULE
R.O 3854224



SDM73410

ROTOR
R.O 3854305

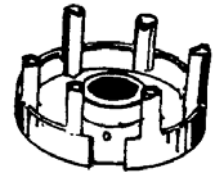

SDM73420

ROTULE
R.O 3854267

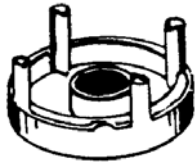

SDM72210

R.O 910599



SDM72200

R.O 985713



SDM72290

R.O 3853833



SDM72130

R.O 811639T



BA.98984

4 CYL.
R.O 982755



SDM73191

Module d'allumage V6/V8 Vortec







SDM73124

Mallory 4/6/8 cylindres



ELECTRICITE

FAISCEAUX BOUGIES	
BA.3030 	BA.3034 
BA.3037 	BA.3040 
Référence	Désignation
BA.3030	Faisceau bougies 4 cyl. classique
BA.3031	Faisceau bougies 470 4 cyl f
BA.3032	Faisceau bpigies 4 cyl. volvo
BA.3033	Faisceau bougies alu/elec 4 cyl.
BA.3034	Faisceau bougies v6 alu electr.
BA.3035	Faisceau bougies 6 cyl l
BA.3036	Faisceau bougies 6 v 185 / 229 / classique
BA.3037	Faisceau bougies v8 clas. 180 gm alu elec.
BA.3039	Faisceau bougies 5.0 / 5.8 l ford efi
BA.3040	Faisceau bougies 5.0l gm alu elec.
BA.3041	Faisceau bougies v8 all etro.
BA.3043	Kit faisceau bougies 5.0 / 5.8l ford
BA.3044	Faisceau bougies v8 all electr.
BA.3045	Faisceau fils bougie 7.5l ford

ELECTRICITE

ALLUMEURS

BA.1677
FORD 351 CID V8
R.O 392-6330



SDM71240
TETE VISEE
R.O 805185A37



SDM71250
TETE VISEE
R.O 805185A36



MP480140
ALLUMEUR ELECTRONIQUE V6



MP480169
ALLUMEUR ELECTRONIQUE V8



VO3854077
CAPTEUR
V8 GM
R.O 3854077



SDM71230
ALLUMEUR V6
RO888751A03



SDM71232
ALLUMEUR V8
RO884794A02



ELECTRICITE

ALLUMEUR ELECTRONIQUE V6 / V8

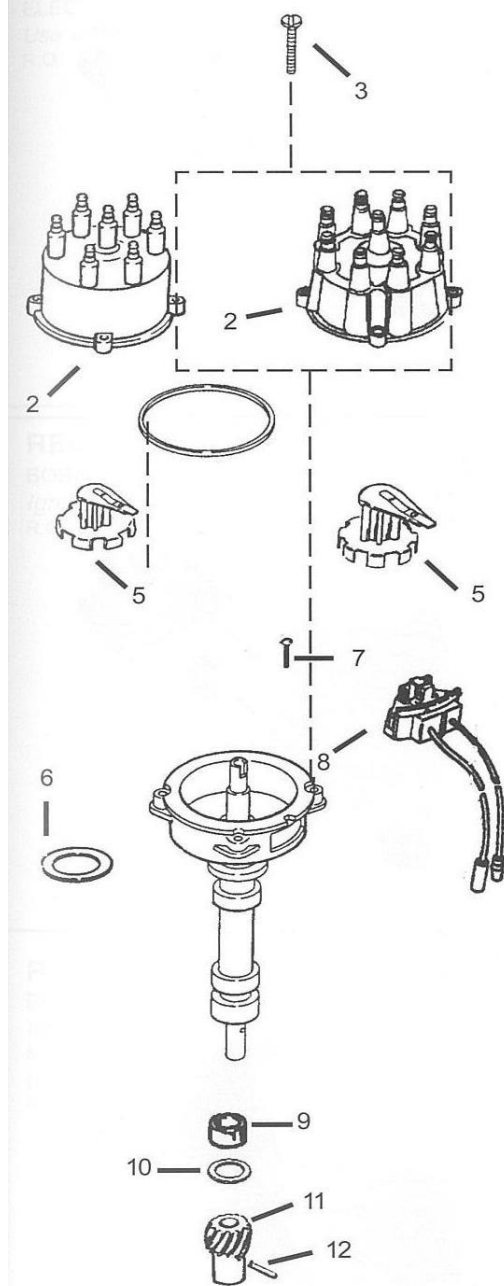

Réf.	N°	R.O	Désignation
SDM71240	1	805185A37	Allumeur V6
SDM71250	1	805185A36	Allumeur V8
SDM71500	2	8154007Q02	Tête allum. V6
SDM71510	2	805759Q01	Tête allum. V8
SDM22305	3	10-90926	Vis
SDM72890	5	13524Q06	Rotor V6
SDM72880	5	13524T1	Rotor V8
SDM31370	6	27-34486-3	Joint
SDM22311	7	10-66686	Vis 1
SDM22312	7	10-72202	Vis 1 ¼
SDM73120	8	87-982150Q02	Module distributeur
SDM21426	9	23-90915	Casque
SDM21661	10	12-90931	Rondelle
SDM19360	11	43-818807	Pignon Delco
SDM22195	12	17-47617	Goupille

SDM71240

ALLUMEUR ELECTRONIQUE V6



SDM71250

ALLUMEUR ELECTRONIQUE V8



ELECTRICITE

KIT ALLUMAGE V6 GM

Remplacement rupteur par allumage électronique

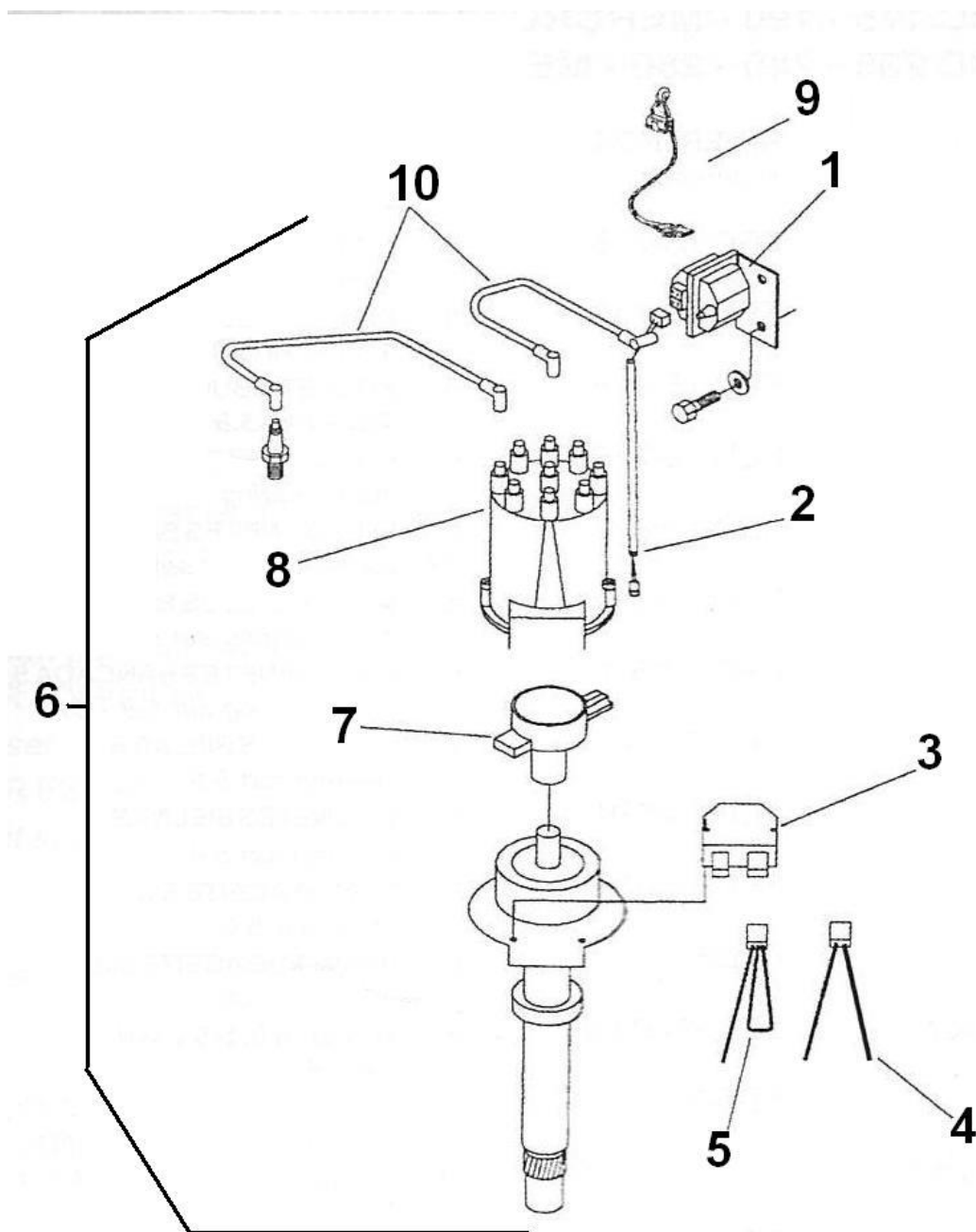

N°	Désignation	Référence	N°	Désignation	référence
	Kit allumeur V6 électronique	BA.AGMV6	6	Allumeur complet électronique V6	MP480140
1	Bobine pour delco performant (HEI)	SDM72113	7	Rotor V6 delco E.I	SDM71110
2	Faisceau resit bobine/allumeur	MP500428	8	Tête allumeur V6 électronique	SDM71410
3	Module de distributeur delco	SDM73190	9	Faisceau bobine	MP500442
4	Faisceau résistance	MP500492	10	Faisceau bougies V6 alu électro.	BA.3034
5	Faisceau résistance	MP009159			