

CHAPITRE XVI

YANMAR

Pages 235 à 240

YANMAR

COUDES ECHAPPEMENT INOX

SDM51990
Y8 – Y12



CO.91224
COUDE SERIE QM



CO.951
COUDE 4JH

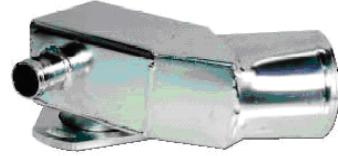

CO.924
COUDE 4LHA/HTE/DTE
119173 – 13501



CO.93370
2GM / 3GM



JOINTS & POCHETTES

J.Y8JC
JOINT DE CULASSE
YS8



J.Y1GMJC
JOINT DE CULASSE
1GM

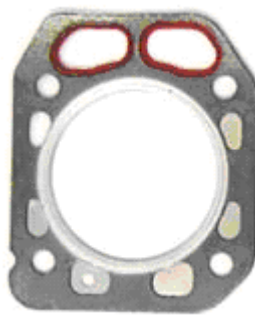

J.Y2GMJC
JOINT DE CULASSE
2GM20

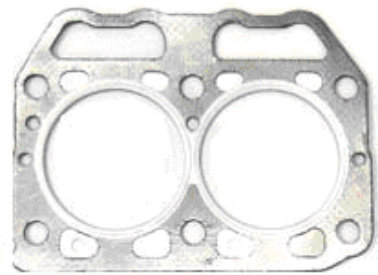

J.Y3JHJC
JOINT DE CULASSE
3JH2E

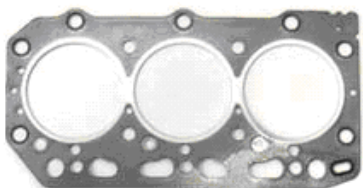

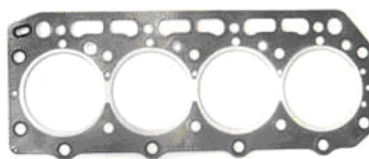

J.Y4JH2JC
JOINT DE CULASSE
4JH2E

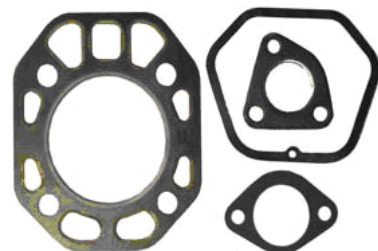

J.Y8R
POCHETTE DE JOINTS
YS8











YANMAR

J.Y1GMC Pochette complète 1GM		J.Y2GMC Pochette complète 2GM20	
			
J.Y3GMC Pochette complète 3GM20			
			
Modèles	Réf. joint de culasse	Réf. Pochette rodage	Réf. Pochette complète
1GM	J.Y1GMJC	J.Y1GMR	J.Y1GMC
1GM10	J.Y1GM10JC	J.Y1GM10R	J.Y1GM10C
2GM20	J.Y2GMJC	J.Y2GMR	J.Y2GMC
2GM20F	J.Y2GMJC	J.Y2GMR	J.Y2GMC
3GM30	J.Y3GMJC	J.Y3GMR	J.Y3GMC
3GM30 (EU)	J.Y3GMJC	J.Y3GMR	J.Y3GMC
3GM30F	J.Y3GMJC	J.Y3GMR	J.Y3GMC
3GM30F (EU)	J.Y3GMJC	J.Y3GMR	J.Y3GMC
3JH2E	J.Y3JHJC	J.Y3JHR	J.Y3JHC
3JH2TE	J.Y3JHJC	J.Y3JHR	J.Y3JHC
3JH3EYEU	J.Y3JHJC	J.Y3JHR	J.Y3JHC
4JHE	J.Y4JHJC	J.Y4 JHR	J.Y4JHC
4JHTE	J.Y4JHJC	J.Y4 JHR	J.Y4JHC
4JHDTE	J.Y4JHJC	J.Y4 JHR	J.Y4JHC
4JH2E	J.Y4JH2JC	J.Y4JH2R	J.Y4JH2C
4JH2TE	J.Y4JH2JC	J.Y4JH2R	J.Y4JH2C
4JH2HTE	J.Y4JH2JC	J.Y4JH2R	J.Y4JH2C
4JH2DTE	J.Y4JH2JC	J.Y4JH2R	J.Y4JH2C
4LHTE	J.Y4LHJC	J.Y4LHR	J.Y4LHC
4LHHTE	J.Y4LHJC	J.Y4LHR	J.Y4LHC
4LHDTE	J.Y4LHJC	J.Y4LHR	J.Y4LHC
4LHSTE	J.Y4LHJC	J.Y4LHR	J.Y4LHC
4LHAHTE	J.Y4LHAJC	J.Y4LHAR	J.Y4LHAC
4LHADTE	J.Y4LHAJC	J.Y4LHAR	J.Y4LHAC
4LHASTE	J.Y4LHAJC	J.Y4LHAR	J.Y4LHAC
YS8	J.Y8JC	J.Y8R	J.Y8C
YS12	J.Y12JC	J.Y12R	J.Y12C
Modèle	Segment	Soupape Admission	Soupape Echappement
1GM10	SE.Y.1GM10 DIAMETRE 75	SO.12051	SO.12050
2GM20			
3GM30			
1GM	SE.Y.1GM DIAMETRE 72	SO.12051	SO.12050
2GM			
3GM			
YS8	SE.YS8	SO.12052	SO.12053
YS12	SE.YS12	SO.12054	SO.12055

YANMAR

ALTERNATEURS & DEMARREURS

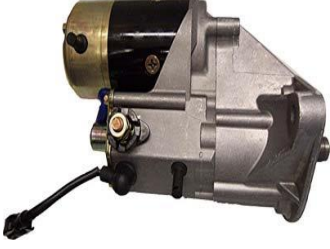
<p>AL.382M 3JH / 4JH / 6LY / 4LH R.O 119573-77200</p> 	<p>AL.430M 1GM / 2GM / 3GM / 3HM R.O 128270-77200</p> 	<p>AL.3161M 12V / 80A NIPPONDENSO R.O 113773-77200</p> 		
<p>AL.3163M 12V / 40A R.O 119836-77200</p> 	<p>D.YA481 1GM / 2GM / 3GM 1GM10 / 2GM20 / 3GM30 R.O 128170-77010</p> 	<p>D.YA480 Y8/12</p> 		
<p>D.YA5219 4JH / QM20 / 2QM20 R.O 129698-77010</p> 	<p>D.YA485 3HM / 3JH / 4JH 15 DENTS R.O 124250-77012</p> 	<p>D.YA5731 6LP-DTE / 6LP-STE R.O 119773-77010</p> 		
Moteurs	Modèles	Description	Réf. Alternateurs	Réf. Démarreurs
YANMAR	SERIE 1 GM	E/S	AL.430M	D.YA481
	SERIE 2QM20	E/S	AL.430M	D.YA482
	2QM30H / 2QMH / 3 QMH	12V / 70A	AL.2112	D.YA5219
	SERIE 4 CYL.	E/S	AL.382M	D.YA483
	4 JH	E/S	AL.382M	D.YA485
	4JH2E	12V / 80A	AL.382M	D.YA485
	6 CYL	DEMULTIPLIER		D.YA5731
	YSM8E / YSM12E	12V / 70A	AL.2112	D.YA480

YANMAR

TURBINES

T.129
TURBINE AVANT 1997



T.100
3GM / 3GM30 / 3QM3M
YS8E / YSB8 / YS12E / YSB12



T.107
3JH2E / TE / 4LH-TE / HTE / DTE / STE
4LHA-HTE / DTE / STE



Modèles	Référence turbines
1GM	T.500
2GM / 3GM / 3GM30	T.101
2GMF / 2GMF20	T.129
2QM20 / 3QM30 / 3HM / 3HM35	T.129
1GM10 / 2QM15 / 2QM20	T.100
3GM / 3GM30 / 3QM30	T.100
3GMF / 3GMF30 / 3QM30	T.129
3HM / HMF / HM35 / HM35F	T.129
4JHE / 4JHTE / 4JH2TE / 3JH2	T.107
3JH2E / 3JH2TE	T.107
YS8E / YSB8 / YS12E / YSB12	T.100
4LH-TE / HTE / DTE / STE	T.107
4LHA-HTE / DTE / STE	T.107
6LP-DTE / STE / DTP / STP	T.124
6LPA-DTE / STE / DTP / STP	T.124
6LY-UTE / STE / 6LY2-STE	T.162
6LYA-STE / 6LY2A-STE / 6CX GTE / GTE2	T.162

FILTRATION



Modèles	Référence filtre huile	Référence filtre carburant
1GM / 2GM / 3GM	B227	PF937
1GM10 / 2GM20 / 3GM30 / 2QM15	B227	PF937
2QM20 / 3QM30 / 3QM	B227	PF937
3HM35 / 3HM35F / 3JH2-E / YSB8// YSB12 / SB8	B227	PF937
SB12 / YSM8 / YSM12	/	PF937
3JH2-TE / 3JH3-E	B227	BF940
4JH-E / 4JH-TE / 4JH-HTE / 4JH-DTE / 4JH2-2	B488	BF940
4JH2-TE / 4JH2-DTE / 4JH2-HTE	B488	BF940
4JH3-E / 4JH3-TE / 4JH3-HTE / 4JH3-HTHE	B1421	BF940
4JH2-UTE	B488	BF940
4LH-TE / 4LH-HTE	B161S	BF7534
4LH-DTE / 4LH-STE / 4LHA-STZ-E	B975	P7103
6LY-UTE / 6LY-STE / 6LY2-STE	BT349	BF7835

YANMAR

INJECTION / INJECTEUR Y8 / Y12 – 1/2/3 GM – 3HM

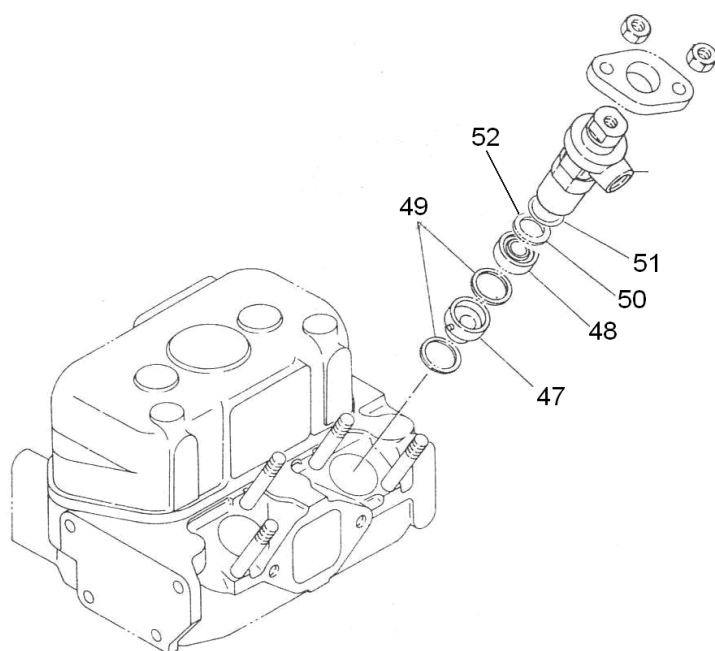

DESIGNATION		REFERENCE
POMPE ALIMENTATION	8 / 12	IP.52023
	1 GM	IP.52021
	2 / 3 GM HM	IP.52020
NEZ INJECTEUR	1 / 2 / 3 GM HM	IN.Y123812
	8 / 12	
INJECTEUR COMPLET	1 / 2 / 3 GM	IE.Y1GM
		IE.Y1GM
	Y8	IE.Y8
	Y12	IE.Y12
CHAMBRE BASSE (47)	1 / 2 / 3 GM	12100011420
	HM	12157511421
	Y8	10420011420
	Y12	10450011420
CHAMBRE HAUTE (48)	1 / 2 / 3 GM	12895011410
	HM	1215511411
	Y8	10420011410
	Y12	
JOINT (49)	1 / 2 / 3 GM	12495011450
	HM	12155011451
	Y8	10120411450
	Y12	10170411450
ISOLANT (50)	1 / 2 / 3 GM	10114711490
	HM	10385411490
	Y8	10385411490
	Y12	
TORIQUE (51)	1 / 2 / 3 GM	24341000260
	HM	
	Y8	
	Y12	
JOINT DE PRECHAMBRE (52)	1 / 2 / 3 GM	12827511500
	HM	
	Y8 / 12	
KIT JOINTS	1 / 2 / 3 GM	J.YA1200